

SILICON RF DEVICES

The background is a solid blue color with several abstract geometric shapes and patterns. A large, light blue pentagon is centered in the upper half. A series of thin, parallel yellow lines radiate from the left side, passing through the pentagon. A vertical column of thin, parallel light blue lines extends from the bottom of the pentagon down towards the bottom right. In the bottom left corner, there is a smaller, darker blue pentagon.

Silicon RF  
Devices

# Better Performance for Radio Communication Network

Mitsubishi Electric Silicon RF Devices are Key parts of RF Power Amplifications for various kind of Mobile Radio, Professional Mobile Radios, Amateur Radios and TELEMATICS for automotive.  
Mitsubishi Electric Silicon RF Devices strongly support for Radio communication network.

Please visit our website for further details.



## LINE UP

Silicon RF Devices	FET	3.6V Operation High Output Power Si MOS FET (Discrete)	SELECTION MAP	PRODUCT LIST
			Page 1	Page 3
		7.2v Operation High Output Power Si MOS FET (Discrete)	Page 1	Page 3~4
		12.5v Operation High Output Power Si MOS FET (Discrete)	Page 1	Page 3
	Hybrid IC	7.2v Operation High Output Power Si MOS FET Module	Page 2	Page 5
		9.6v Operation High Output Power Si MOS FET Module	Page 2	Page 5
		12.5v Operation High Output Power Si MOS FET Module	Page 2	Page 5~6

## SELECTION MAP

### HIGH OUTPUT POWER Si MOS FET (DISCRETE)

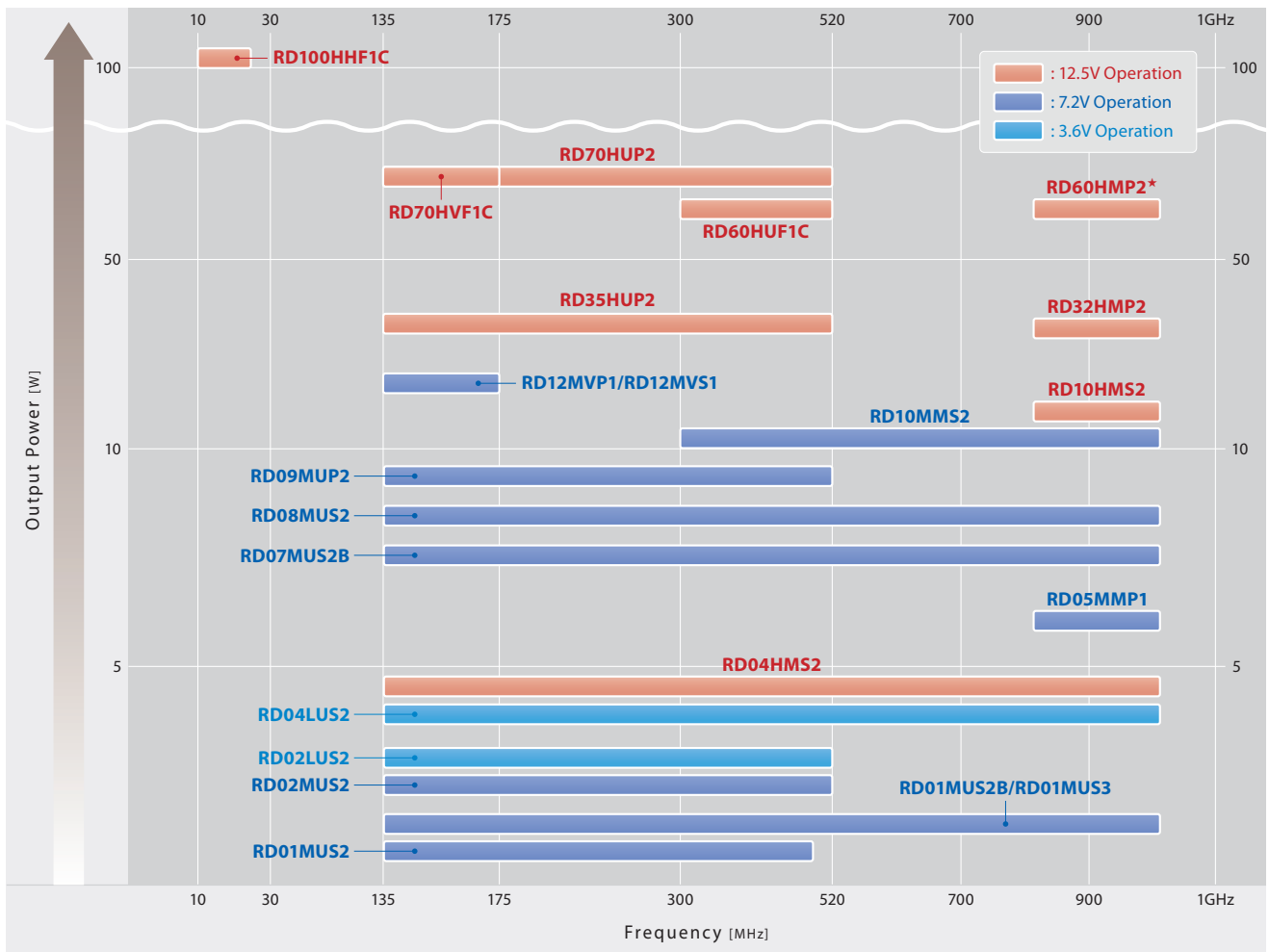

\*: New product

LINE UP  
SELECTION MAP  
PRODUCT LIST  
APPLICATION  
PACKAGE OUTLINE

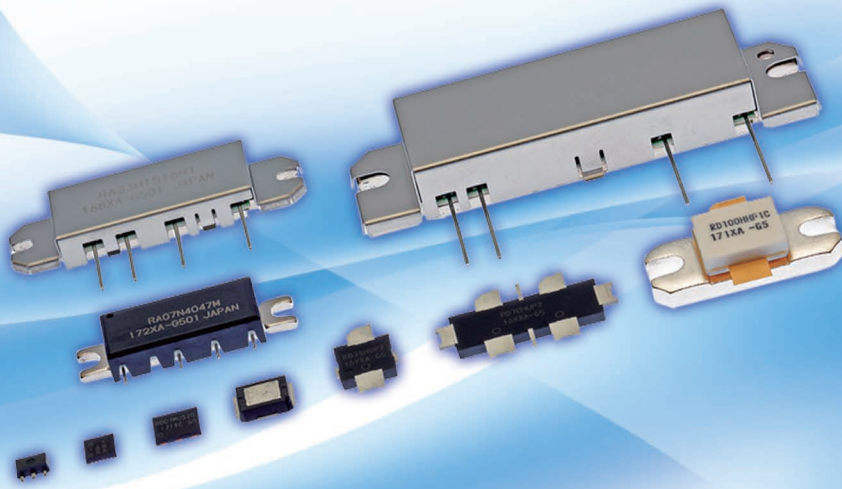

## HIGH OUTPUT POWER Si MOS FET MODULE

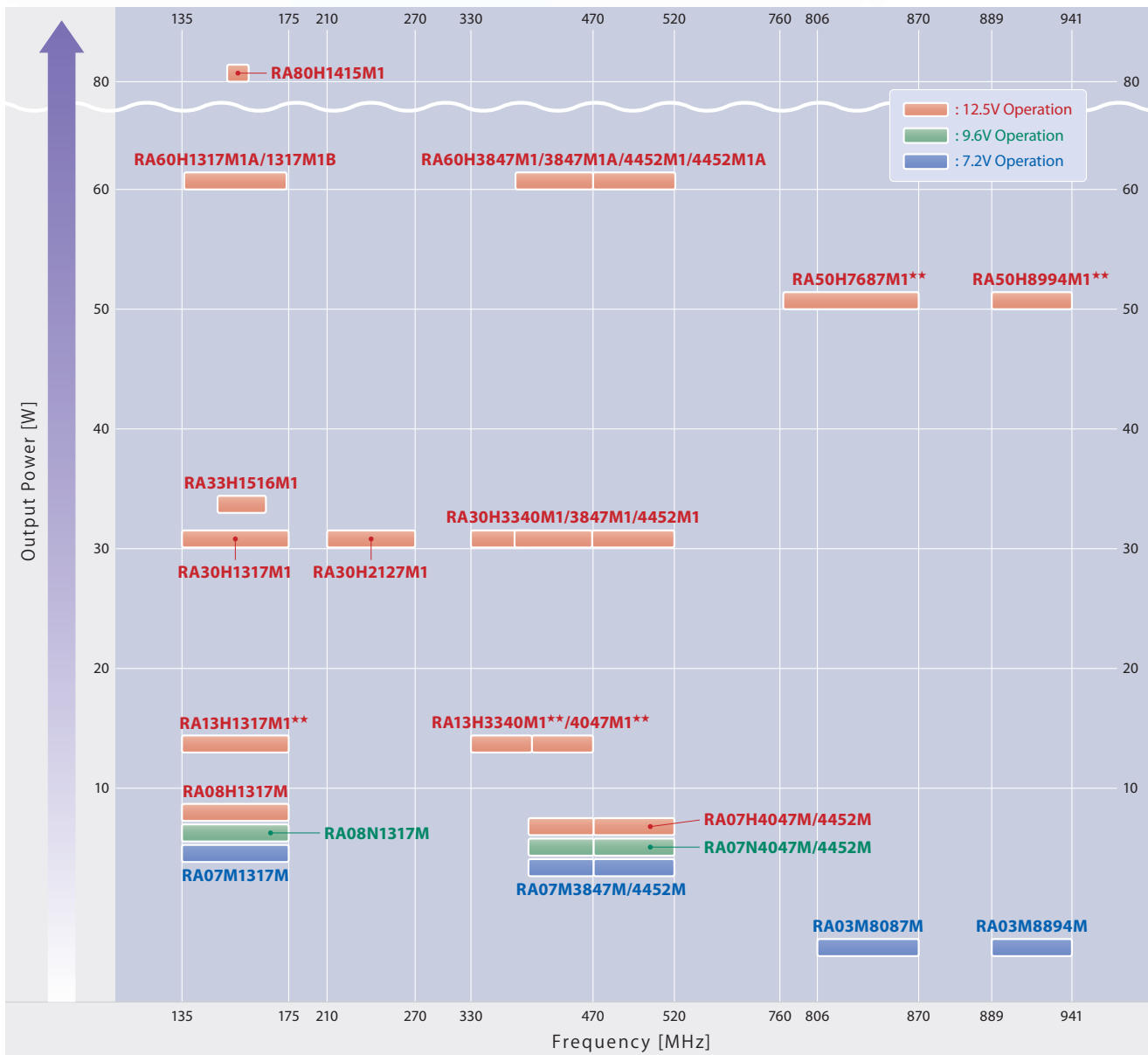

\*\* : Under development

## PRODUCT LIST

## 3.6V OPERATION HIGH OUTPUT POWER Si MOS FET (DISCRETE)

Type Number	Structure	Max.ratings		V <sub>DD</sub> [V]	Frequency Band	Pin [W]	Po (Typ.) [W]	η <sub>D</sub> (Typ.) [%]	Package Type
		V <sub>bss</sub> [V]	P <sub>ch</sub> [W]						
RD02LUS2	Si, MOS <sup>†</sup>	25	15.6	3.6	UHF	0.2	2.3	70	SOT-89
RD04LUS2	Si, MOS <sup>†</sup>	25	46.3	3.6	UHF	0.4	4.5	65	SLP

Ta=25°C †: Gate Protection Diode

## 7.2V OPERATION HIGH OUTPUT POWER Si MOS FET (DISCRETE)

Type Number	Structure	Max.ratings		V <sub>DD</sub> [V]	Frequency Band	Pin [W]	Po (Typ.) [W]	η <sub>D</sub> (Typ.) [%]	Package Type
		V <sub>bss</sub> [V]	P <sub>ch</sub> [W]						
RD01MUS2	Si, MOS <sup>†</sup>	40	12.5	7.2	UHF	0.03	1.3	65	SOT-89
RD01MUS2B	Si, MOS <sup>†</sup>	25	12.5	7.2	VHF	0.03	1.4	75	SOT-89
					UHF	0.03	1.6	70	
					900	0.03	1.5	65	
RD02MUS2	Si, MOS <sup>†</sup>	40	50	7.2	VHF	0.05	3	65	SLP
					UHF	0.05	3	65	
RD05MMP1	Si, MOS <sup>†</sup>	30	73	7.2	900	0.7	6	46	PMM
RD07MUS2B	Si, MOS <sup>†</sup>	30	50	7.2	VHF	0.3	7.2	65	SLP
					UHF	0.4	8	63	
					900	0.5	7	58	
RD08MUS2	Si, MOS <sup>†</sup>	25	46	7.2	VHF	0.2	8.5	65	SLP
					UHF	0.2	8.5	65	
					900	0.25	7	55	
RD09MUP2	Si, MOS <sup>†</sup>	40	83	7.2	VHF	0.7	9	72	PMM
					UHF	0.8	9	60	
RD10MMS2	Si, MOS <sup>†</sup>	40	62	7.2	900	1	12	58	SLP
RD12MVP1	Si, MOS <sup>†</sup>	50	125	7.2	VHF	0.5	12	57	PMM
RD12MVS1	Si, MOS <sup>†</sup>	50	50	7.2	VHF	1	12	57	SLP

Ta=25°C †: Gate Protection Diode

## 12.5V OPERATION HIGH OUTPUT POWER Si MOS FET (DISCRETE)

Type Number	Structure	Max.ratings		V <sub>DD</sub> [V]	Frequency Band	Pin [W]	Po (Typ.) [W]	η <sub>D</sub> (Typ.) [%]	Package Type
		V <sub>bss</sub> [V]	P <sub>ch</sub> [W]						
RD04HMS2	Si, MOS <sup>†</sup>	40	50	12.5	VHF	0.2	5.5	73	SLP
					UHF	0.2	6	62	
					900	0.2	5	58	
RD10HMS2	Si, MOS <sup>†</sup>	40	50	12.5	900	0.6	11	65	SLP
RD32HMP2	Si, MOS <sup>†</sup>	40	197	12.5	900	5	35	64	HPM005
RD35HUP2	Si, MOS <sup>†</sup>	40	166	12.5	UHF	3	35	55	HPM005
RD60HUF1C	Si, MOS <sup>†</sup>	30	150	12.5	UHF	10	65	55	Ceramic
RD60HMP2*	Si, MOS <sup>†</sup>	40	385	12.5	900	7	70	65	HPM006
RD70HVF1C	Si, MOS <sup>†</sup>	30	150	12.5	VHF	4	75	60	Ceramic
					UHF	10	55	55	
RD70HUP2	Si, MOS <sup>†</sup>	40	300	12.5	VHF	4	84	74	HPM006
					UHF	5	75	64	
RD100HHF1C	Si, MOS	50	176.5	12.5	HF	7	110	60	Ceramic

Ta=25°C †: Gate Protection Diode \* : New product

## 7.2V OPERATION HIGH OUTPUT POWER Si MOS FET (DUAL FET DISCRETE)

Type Number	Structure	Max.ratings		VDD [V]	Frequency Band	Pin [W]	Po (Typ.) [W]	$\eta_D$ (Typ.) [%]	Package Type
		V <sub>DSS</sub> [V]	P <sub>ch</sub> [W]						
RD01MUS3	Si, MOS <sup>†</sup>	25	6.2	7.2	UHF	0.001	0.15	60	QFN (4mm)
	Si, MOS <sup>†</sup>	25	8.3	7.2	UHF	0.1	1.8	70	

Ta=25°C †: Gate Protection Diode

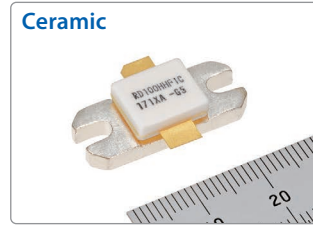
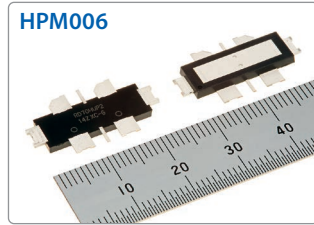
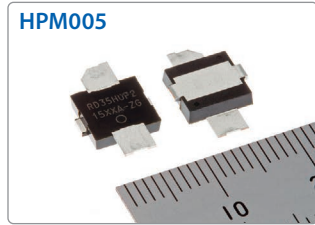
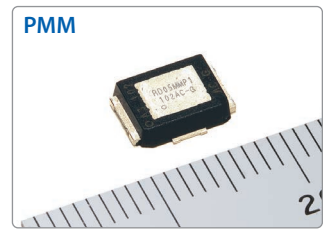
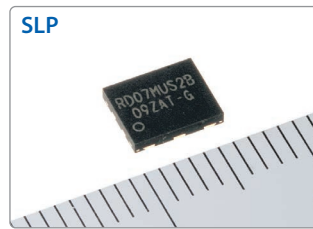
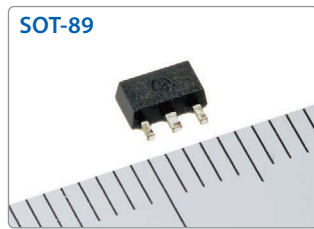
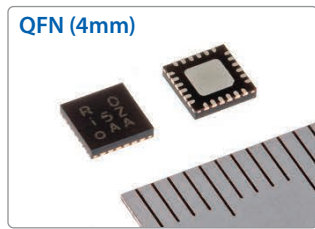

## Type Name Definition of Silicon RF Devices

### HIGH OUTPUT POWER Si MOS FET (Discrete Devices)

**RD 08 M U S 2**

**A** Si MOS FET (Discrete)

**B** Output Power (W)

**C** Operation Voltage (V)

Symbol	Voltage
L	3.6V
M	7.2V
H	12.5V

**D** Frequency Range (MHz)

Symbol	Frequency Range
H	30MHz
V	175MHz
U	520MHz
M	900MHz

**E** Outline

Symbol	Segment
S	Mold
F	Flange
P	Power Mold Mini

**F** Serial Number

### HIGH OUTPUT POWER Si MOS FET MODULE

**RA 07 M 4452 M**

**A** Module

**B** Output Power (W)

**C** Operation Voltage (V)

Symbol	Voltage
M	7.2V
N	9.6V
H	12.5V

**D** Frequency Range (MHz)

Symbol (Example)	Frequency Range (Example)
4452	440~520MHz
1317	135~175MHz

**E** Frequency Unit

Symbol	Unit
M	MHz
G	GHz

Note: Type number show the outline of products. For detail specification, Please confirm a formal specification.

## PRODUCT LIST

## 7.2V OPERATION HIGH OUTPUT POWER Si MOS FET MODULE

Type Number	Max.ratings V <sub>DD</sub> [V]	f [MHz]		V <sub>DD</sub> [V]	Pin [W]	Po (min) [W]	η <sub>T</sub> (min) [%]	Package Type
		min	max					
RA03M8087M	9.2	806	870	7.2	0.05	3.6	32* <sup>1</sup>	H46S
RA03M8894M	9.2	889	941	7.2	0.05	3.6	32* <sup>1</sup>	H46S
RA07M1317M	9.2	135	175	7.2	0.02	6.5	45* <sup>2</sup>	H46S
RA07M3847M	9.2	378	470	7.2	0.05	7	40* <sup>3</sup>	H46S
RA07M4452M	9.2	440	520	7.2	0.05	7	40* <sup>3</sup>	H46S

T<sub>a</sub>=25°C \*1: Po=3.6W時 \*2: Po=6W時 \*3: Po=6.5W時

## 9.6V OPERATION HIGH OUTPUT POWER Si MOS FET MODULE

Type Number	Max.ratings V <sub>DD</sub> [V]	f [MHz]		V <sub>DD</sub> [V]	Pin [W]	Po (min) [W]	η <sub>T</sub> (min) [%]	Package Type
		min	max					
RA08N1317M	13.2	135	175	9.6	0.02	8	50* <sup>1</sup>	H46S
RA07N4047M	13.2	400	470	9.6	0.05	7.5	43* <sup>2</sup>	H46S
RA07N4452M	13.2	440	520	9.6	0.05	7.5	43* <sup>2</sup>	H46S

T<sub>a</sub>=25°C \*1: When Po=8W \*2: When Po=7W

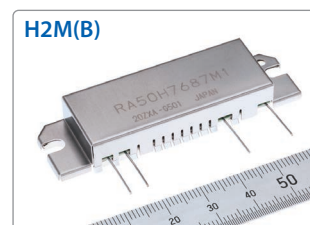
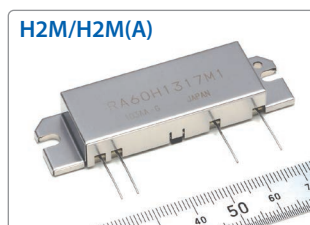
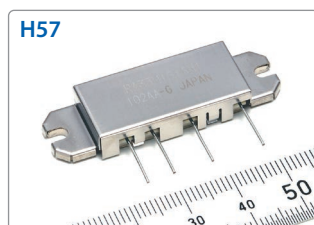
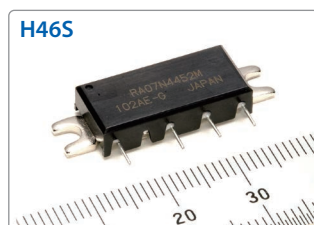

## 12.5V OPERATION HIGH OUTPUT POWER Si MOS FET MODULE

Type Number	Max. ratings V <sub>DD</sub> [V]	f [MHz]		V <sub>DD</sub> [V]	P <sub>in</sub> [W]	P <sub>o</sub> (min) [W]	η <sub>T</sub> (min) [%]	Package Type
		min	max					
RA08H1317M	13.2	135	175	12.5	0.02	8	40* <sup>1</sup>	H46S
RA07H4047M	13.2	400	470	12.5	0.02	7	40* <sup>2</sup>	H46S
RA07H4452M	13.2	440	520	12.5	0.02	7	40* <sup>2</sup>	H46S
RA13H1317M1*	17	135	175	12.5	0.05	13	40	H2M
RA13H3340M1*	17	330	400	12.5	0.05	13	35	H2M
RA13H4047M1*	17	400	470	12.5	0.05	13	35	H2M
RA30H1317M1	17	135	175	12.5	0.05	35	40	H2M
RA30H2127M1	17	210	275	12.5	0.05	30	40	H2M
RA30H3340M1	17	330	400	12.5	0.05	30	40	H2M
RA30H3847M1	17	378	470	12.5	0.05	30	42	H2M
RA30H4452M1	17	440	520	12.5	0.05	30	42	H2M
RA33H1516M1	17	154	164	12.5	0.01	33	50	H57
RA50H7687M1**	17	763	870	12.5	0.05	50	40	H2M(B)
RA50H8994M1**	17	896	944	12.5	0.05	50	40	H2M(B)
RA60H1317M1A	17	136	174	12.5	0.05	60	45	H2M
RA60H1317M1B*	17	136	174	12.5	0.05	60	45	H2M(A)
RA60H3847M1	17	378	470	12.5	0.05	60	40	H2M
RA60H3847M1A*	17	378	470	12.5	0.05	60	40	H2M(A)
RA60H4452M1	17	440	520	12.5	0.05	60	40	H2M
RA60H4452M1A*	17	440	520	12.5	0.05	60	40	H2M(A)
RA80H1415M1	17	144	148	12.5	0.05	80	50	H2M
		136	174			60		

T<sub>a</sub>=25°C \*: V<sub>GG1</sub>, V<sub>GG2</sub> Separation type \*1: When P<sub>o</sub>=8W \*2: When P<sub>o</sub>=7W ★: New product ★★: Under development

SiRF devices are compliant with the **RoHS** (2011/65/EU, (EU)2015/863).

## APPLICATION

## 3.6V OPERATION RECOMMENDED LINE UP

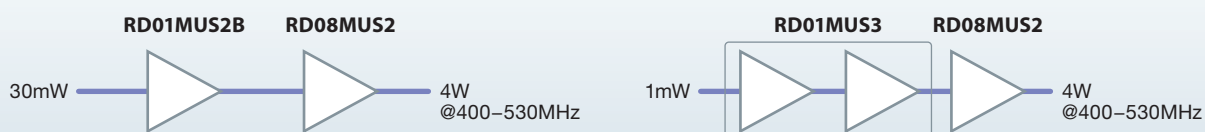

## 7.2V OPERATION RECOMMENDED LINE UP



## 12.5V OPERATION RECOMMENDED LINE UP

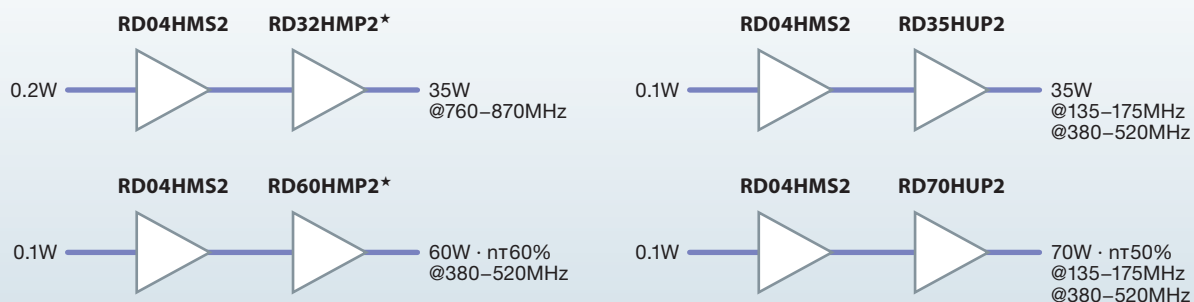

★: New product

## Precautions for the use of Mitsubishi Electric silicon RF devices

- 01.This general catalog do not guarantee the product specifications. Please confirm additional details regarding operation of these products from the formal specification sheet. For copies of the formal specification sheets, please contact one of our sales offices from the list of contact addresses listed on the last page for further information.
- 02.RA series products (RF power amplifier modules) and RD series products (RF power transistors) are designed for consumer mobile communication terminals and were not specifically designed for use in other applications. In particular, while these products are highly reliable for their designed purpose, they are not manufactured under a quality assurance testing protocol that is sufficient to guarantee the level of reliability typically deemed necessary for critical communications elements. Examples of critical communications elements would include transmitters for base station applications and fixed station applications that operate with long term continuous transmission and a higher on-off frequency during transmitting, especially for systems that may have a high impact to society.
- 03.RA series and RD series products use MOSFET semiconductor technology. They are sensitive to ESD voltage therefore appropriate ESD precautions are required.
- 04.In order to maximize reliability of the equipment, it is better to keep the devices temperature low. It is recommended to utilize a sufficient sized heat-sink in conjunction with other cooling methods as needed (fan, etc.) to keep the case temperature for RA series products lower than 60deg/C under standard conditions, and less than 90deg/C under extreme conditions.
- 05.RA series products are designed to operate into a nominal load impedance of 50 ohms. Under the condition of operating into a severe high load VSWR approaching an open or short, an over load condition could occur. In the worst case there is risk for burn out of the transistors and smoking of other parts including the substrate in the module.
- 06.The formal specification includes a guarantee against parasitic oscillation under a specified maximum load mismatch condition. The inspection for parasitic oscillation is performed on a sample basis on our manufacturing line. It is recommended that verification of no parasitic oscillation be performed at the completed equipment level also.
- 07.For specific precautions regarding assembly of these products into the equipment, please refer to the supplementary items in the specification sheet.
- 08.Warranty for the product is void if the products protective cap (lid) is removed or if the product is modified in any way from it's original form.
- 09.For additional "Safety first" in your circuit design and notes regarding the materials, please refer the last page of this manual.
- 10.Please refer to the additional precautions in the formal specification sheet.

**mitsubishi electric**  
**SEMICONDUCTORS**  
**GLOBAL WEB SITE**

<https://www.MitsubishiElectric.com/semiconductors/>





# PACKAGE OUTLINE

LINE UP

SELECTION MAP

PRODUCT LIST

APPLICATION

PACKAGE OUTLINE

## QFN (4mm)

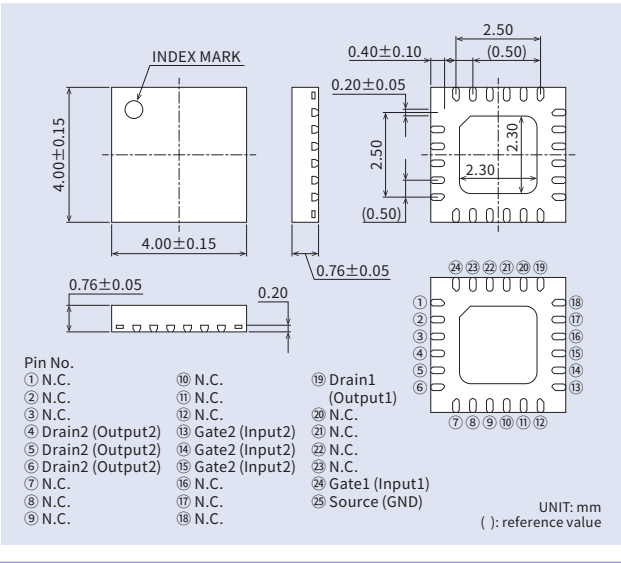

## H46S

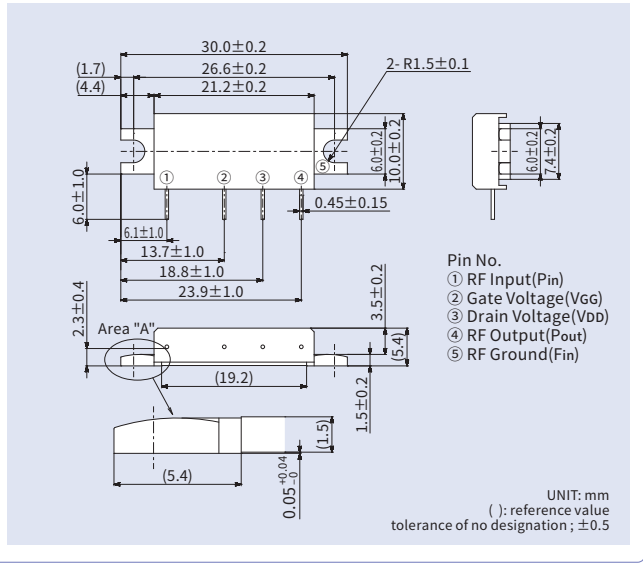

## H57

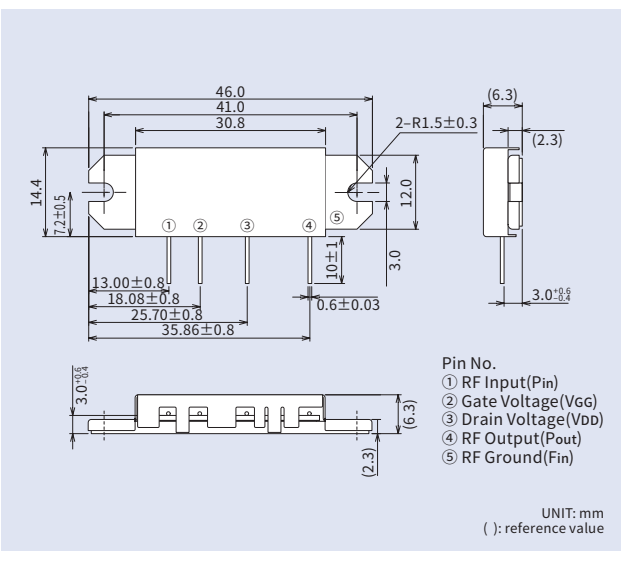

## H2M/H2M(A)

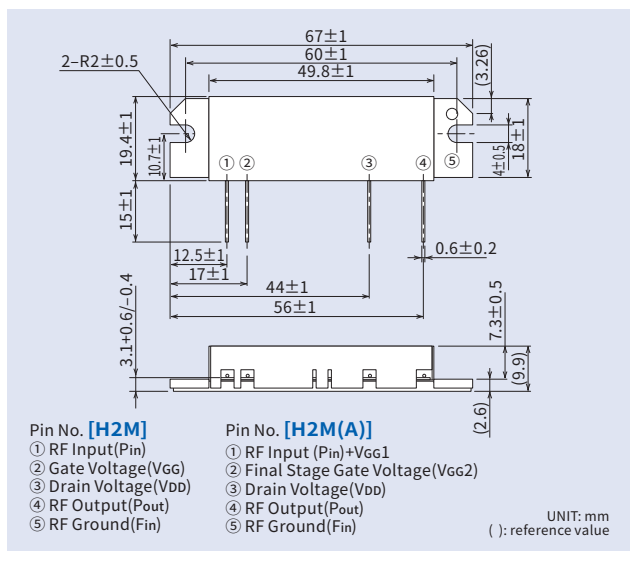

## H2M(B)

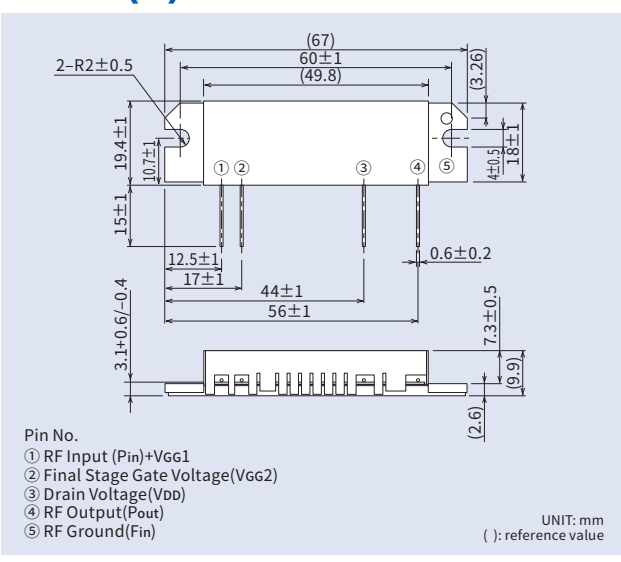



## Mitsubishi Electric Semiconductors & Devices Website

[www.MitsubishiElectric.com/semiconductors/](http://www.MitsubishiElectric.com/semiconductors/)



### Keep safety first in your circuit designs!

- Mitsubishi Electric Corporation puts the maximum effort into making semiconductor products better and more reliable, but there is always the possibility that trouble may occur with them. Trouble with semiconductors may lead to personal injury, fire or property damage. Remember to give due consideration to safety when making your circuit designs, with appropriate measures such as (i) placement of substitutive, auxiliary circuits, (ii) use of non-flammable material or (iii) prevention against any malfunction or mishap.

### Notes regarding these materials

- These materials are intended as a reference to assist our customers in the selection of the Mitsubishi Electric Semiconductor product best suited to the customer's application; they do not convey any license under any intellectual property rights, or any other rights, belonging to Mitsubishi Electric Corporation or a third party.
- Mitsubishi Electric Corporation assumes no responsibility for any damage, or infringement of any third-party's rights, originating in the use of any product data, diagrams, charts, programs, algorithms, or circuit application examples contained in these materials.
- All information contained in these materials, including product data, diagrams, charts, programs and algorithms represents information on products at the time of publication of these materials, and are subject to change by Mitsubishi Electric Corporation without notice due to product improvements or other reasons. It is therefore recommended that customers contact Mitsubishi Electric Corporation or an authorized Mitsubishi Electric Semiconductor product distributor for the latest product information before purchasing a product listed herein.
- The information described here may contain technical inaccuracies or typographical errors. Mitsubishi Electric Corporation assumes no responsibility for any damage, liability, or other loss rising from these inaccuracies or errors. Please also pay attention to information published by Mitsubishi Electric Corporation by various means, including the Mitsubishi Electric Semiconductor home page (<http://www.MitsubishiElectric.com/semiconductors/>).
- When using any or all of the information contained in these materials, including product data, diagrams, charts, programs, and algorithms, please be sure to evaluate all information as a total system before making a final decision on the applicability of the information and products. Mitsubishi Electric Corporation assumes no responsibility for any damage, liability or other loss resulting from the information contained herein.
- Mitsubishi Electric Corporation semiconductors are not designed or manufactured for use in a device or system that is used under circumstances in which human life is potentially at stake. Please contact Mitsubishi Electric Corporation or an authorized Mitsubishi Electric Semiconductor product distributor when considering the use of a product contained herein for any specific purposes, such as apparatus or systems for transportation, vehicular, medical, aerospace, nuclear, or undersea repeater use.
- The prior written approval of Mitsubishi Electric Corporation is necessary to reprint or reproduce in whole or in part these materials.
- If these products or technologies are subject to the Japanese export control restrictions, they must be exported under a license from the Japanese government and cannot be imported into a country other than the approved destination.
- Any diversion or re-export contrary to the export control laws and regulations of Japan and/or the country of destination is prohibited.
- Please contact Mitsubishi Electric Corporation or an authorized Mitsubishi Electric Semiconductor product distributor for further details on these materials or the products contained therein.

## MITSUBISHI ELECTRIC CORPORATION

HEAD OFFICE: TOKYO BLDG., 2-7-3, MARUNOUCHI, CHIYODA-KU, TOKYO 100-8310, JAPAN  
[www.MitsubishiElectric.com](http://www.MitsubishiElectric.com)